Operation Manual

Supra R22

High speed Centrifuge

Product Model Name : _____

Date of Purchase : _____



Supra R22
Research Use Only

© 2018 Hanil Scientific Inc.

If you have any questions, contact our Technical Support Center.
+82-2-3452-8966 / techsupport@ihanol.com

www.ihanol.com

The appearance or specifications of the device is subject to partial change for improvement.

INDEX

1. General Considerations -----	4
1.1 Safety -4	
1.2 Transport & Storage - 5	
1.3 Safety label on the Device - 5	
1.4 Electric safety - 5	
2. Product Description -----	6
2.1 Structure - 6	
2.2 Delivery package - 6	
2.3 Technical Specifications - 7	
3. Installation -----	8
3.1 Packing Inspection- 8	
3.2 Installation - 8	
3.3 Power Connection - 10	
3.4 Opening/Closing the Lid - 10	
3.5 Using the Rotor - 11	
3.6 Loading Tubes - 12	
3.7 Recommended Tubes - 13	
4. Operation -----	14
4.1 Control Panel - 14	
4.2 Setting Speed - 15	
4.3 Setting Run Time - 16	
4.4 Setting Temperature - 16	
4.5 Setting Temperature Limit - 16	
4.6 Setting Acceleration/Deceleration - 17	
4.7 Saving/Calling up a Program - 17	
4.8 Start/Stop/Pulse Run - 18	
5. Maintenance -----	19
5.1 Care Instructions - 19	
5.2 Cleaning - 19	
5.3 Care Instructions for Refrigerated device - 20	
6. Troubleshooting -----	21
6.1 Possible Problems - 21	
6.2 Error Codes - 22	
6.3 Emergency Lid Open - 23	
7. Rotor -----	24

1. General Considerations

1.1 Safety

Follow precautions and all the safety requirements described on this user manual to prevent any damage and failure of device and loss of lives.

1. The device should be installed on flat surface to maintain level.
2. Check the voltage to be used, before connecting the device to the power source.
3. Only use rotors, parts, and accessories provided by Hanil Scientific Inc.
Hanil Scientific Inc. is not responsible for damages of the device and accidents caused by using parts and accessories not recommended.
4. Do not exceed the maximum rated speed of the rotor or buckets in use.
5. Make sure to prepare necessary safety measures before using samples that are toxic or radioactive samples or pathogenic or samples or infectious blood.
6. Substances that may generate volatile or explosive vapor can not be deviced.
7. The balancing work of samples should done in advance before operation.
8. To ensure safe use of the device, do not expose the device to strong acids, strong bases, cesium, salt, or alkaline detergents.
8. If the device is contaminated by toxic or radioactive samples or infectious blood samples, remove contaminants completely and take needful actions such as ventilation or isolation of device.
9. Before operation, rotor and chamber should be dry.
10. Do not attempt to slow or stop the spinning rotor by hand.
11. Only device with rotor and rotor door firmly tightened.
12. Do not block vents.
13. When serving the device, be sure to remove contaminants in advance.
14. Please contact the place of purchase or Hanil Scientific Inc. for product repairs.
15. According to IEC61010-2-020 maintain a 30cm “clearance envelope” around the device while the rotor is spinning.
16. Turn the power switch off after using the device.
17. Unplug the power plug before cleaning or left unused for a long period of time.
18. Don't lean against the device

1. General Considerations

1.2 Transport & Storage



- The device and the accessories must only be stored in dry rooms.
- Only lift and transport the device with sufficient number of helpers.

-Storage-

Ambient temperature 5°C~40°C

Maximum relative humidity 30%~85%

Air pressure 500~1060hpa

-Transport-

Ambient temperature -10°C~40°C

Maximum relative humidity 10%~90%

Air pressure 500~1060hpa

1.3 Safety label on the Device

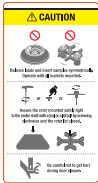

Insert the rotor and tubes symmetrically.

Firmly tighten the rotor door.

Watch your fingers when close the lid.



Caution/Warning



Warning for electric shock



Ground connection

1.4 Electric safety

1. It is recommended that switchgear or circuit breaker and overcurrent protection devices should be installed near the device.
2. Use a power cord only provided with the device.
3. Do not use an extension cord.
4. Do not place anything on the powercable.
5. If you have the following emergencies, shut off the power supply and unplug the powercord from outlet and contact your place of purchase or Hanil Scientific Inc.
 - Unusual noises or smell from the equipment.
 - Damage or wear of a power cord.
 - Breakdown of circuit breaker, fuse or safety device.
 - If you spill liquid on the equipment.
 - If the equipment has been damaged.

2. Product Description

2.1 Structure

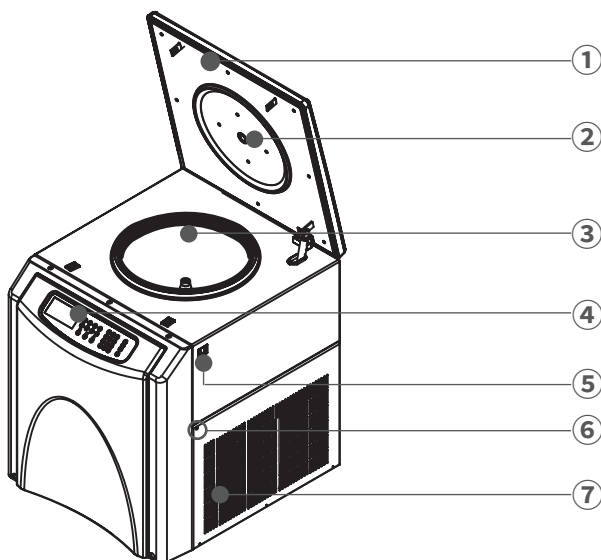

- ① Lid
- ② RPM measuring window
- ③ Chamber
- ④ Control Panel
- ⑤ Power Switch
- ⑥ Emergency Release Hole
- ⑦ Ventilation Slots

2.2 Delivery package

- Main Device
- Operating manual
- T-wrench
- Rotors & Accessories on request

2. Product Description

2.3 Technical Specifications

Max. RPM	22,000 rpm
Max. RCF	57,358 xg
Time	< 100 hr, continuous, pulse
Max. Capacity	4 x 1,000 mL
Temperature range	-10°C to 40°C
ACC/DEC steps	10/10 steps
Program memory	100
Rotor Identification	Automatic
Imbalance cutoff / tracking	Yes
Noise level	< 65 dB
Dimension (W x D x H, mm)	668.7 x 800.6 x 891.3
Weight without rotor	230 kg
Power requirement	3.4 kVA
Power input (V, Hz)	210~240V 60 Hz (110V, 50 Hz optional)
Cat. No.	SU-R22

3. Installation

3.1 Packing Inspection



- Check packing conditions carefully, before unpacking.
- Contact Hanil Scientific Inc. immediately if damages found.
- Check the delivery for completeness.

► You can get contact details on the packing box or manual.

3.2 Installation

3.2.1 Selecting the Location

Installation on hard and flat ground.

- Centrifuge should be installed on hard and flat place.
- If the centrifuge is installed in an inclined place, the shaft may be bent due to the weight of the rotor.

Good ventilation.

- For air circulation and safety, maintain a 30cm “clearance envelope” around the centrifuge while the rotor is spinning.



Constant temperature/humidity

- Centrifuge equipped with the sensitive electronic software which is fragile with humidity and temperature.
- Must avoid direct ray or heater and be put in the ambience of controlled temp.and air.

Avoid the corrosive gas

- Install the centrifuge in a place where corrosive gas is not generated.
- Sulfur dioxide gas and chlorine gas may cause corrosion.

Leveling

- The device should be operated on a flat surface.
Use a leveler tool to check the device is level.

3. Installation

3.2 Installation

3.2.1 Leveling the Device



· If the device is not installed horizontally, it may cause vibration, noise or malfunction.

1. Place the device on a hard and flate place.
2. Put the leveler tool on the device.



2. Turn the leveling foot on the botton of the device to level the device.
▶ Adjust the leveling foot so that the bubble in the leveler tool is at the center of the line.

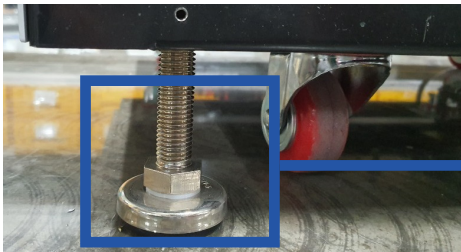

Leveling Foot

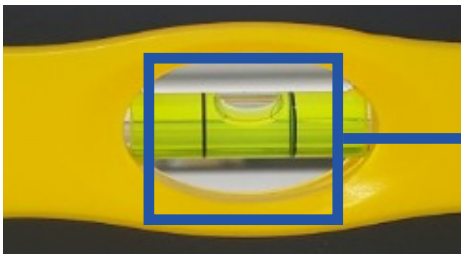

Bubble in the leveler tool is at the center of the line.

3. Installation

3.3 Power Connection



- Connect the device to voltage sources which correspond to the electrical requirements on the label attached to the device.
- Only use a socket provided Hanil Scientific Inc.

1. You can choose a embedded socket or a movable socket
2. Switch the centrifuge on using the power power switch on the right side of the device.

3.4 Opening/Closing the Lid



- If the lid is not closed, the device does not operate.

Opening the lid

1. Press the Lid button

Closing the lid

1. Put both hands on the lid and close it with light force.

3. Installation

3.5 Installing/Uninstalling the Rotor

1. Clean the motor shaft and chamber.
2. Load the rotor vertically onto the motor shaft.
3. Place the rotor lid on the rotor body.
4. Turn the rotor lid handle clockwise.
 - ▶ Install: Turn the handle clockwise.
 - ▶ Uninstall: Turn the handle counterclockwise.
5. Check the rotor to make sure it loaded firmly.

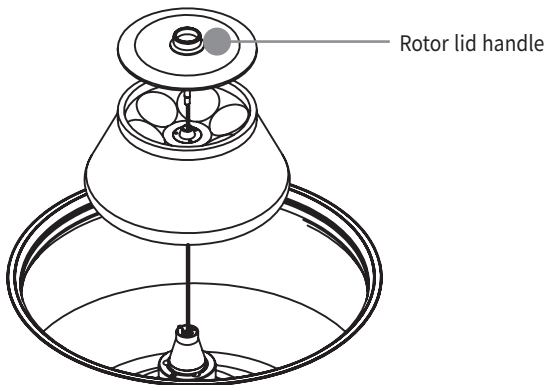

3. Installation

3.6 Loading Tubes



· Use recommended tubes by Hanil Scientific Inc.

- Always use the same type of tube.
- Weight, Density and volume of opposing tubes must be same.
- Check symmetric loading by balancing the tubes with scales.

Correct Arrangement

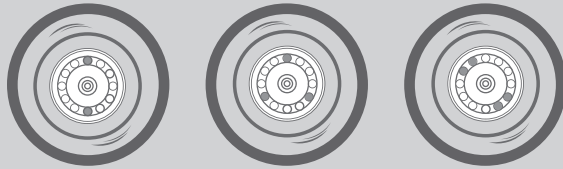

Wrong Arrangement

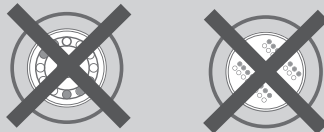

3. Installation

3.7 Recommended Tubes

Rotor	Adaptor	Bore (Ø x L, mm)	Tube Capacity	Tube	Tube Material	Max. g-force(xg)	Tube dimension O.D. x h, mm
A10-12	-	16.3 x 74.5	10 mL	Nalgene 3119-0010	PPCO	50,000 xg	16.1 x 80.5
A15S-12	-	17 x 96	15 mL	Nalgene 3110-0160 (cap available separately DS3111-0018)	PPCO	50,000 xg	15.8 x 112.8
A15c-12	-	17 X 115	15 mL conical	FALCON 352096 Eppendorf 0030122151	PP	12,000 xg 19,500 xg	17 x 120 17 x 121
A50-6 A50-8	-	29 x 100	50 mL	Nalgene 3118-0050 Nalgene 3119-0050	PC PPCO	50,000 xg 100,605 xg	28.8 x 106.4 28.8 x 105.9
	TR15(50)	17 x 94	50 mL	Nalgene 3110-0150 (cap available separately DS3111-0016)	PPCO	50,000 xg	15.8 x 112.8
	TR15c(50)	17 x 105	15 mL conical	FALCON 352096 Eppendorf 0030122151 Corning 430052	PP	12,000 xg 19,500 xg 12,000 xg	17 x 120 17 x 121 17 x 118.5
A50c-6	-	30 x 108.6	50 mL conical	FALCON 352070	PP	16,000 xg	30 x 115
A85-6	-	38.3 x 95	85 mL	Nalgene 3118-0085	PC	50,000 xg	38.2 x 105.2
	TR50(85)	29 x 95	50 mL	Nalgene 3118-0050 3119-0050	PC PPCO	50,000 xg 100,605 xg	28.8 x 106.4 28.8 x 105.9
	TR50c(85)	29.5 x 100	50 mL conical	Orange 4440100N FALCON 352070 SPL 50050	PP PP PP	12,000 xg 16,000 xg 14,000 xg	30 x 114 30 x 115 30 x 115
	TR15(85)	17 x 94	15 mL	Nalgene 3110-0150 (cap available separately DS3111-0016)	PPCO	50,000 xg	15.8 x 112.8
	TR15c(85)	17 x 100	15 mL conical	FALCON 352096	PP	12,000 xg	17 x 120
A250-6	-	62 x 103	250 mL	Nalgene 3120-0250	PPCO	13,200 xg	61.8 x 125.2
			250 mL	Nalgene 3122-0250	PC	27,500 xg	61.8 x 125.2
			250 mL	Autofil 1801-RLS Autofil 1803-RLS	PP	8,250 xg 27,500 xg	61 x 127
			250 mL	Autofil 1802-RLS Autofil 1804-RLS	PC	8,250 xg 31,700 xg	61 x 127
A500-6	-	70 x 141	500 mL	Autofil 1805-RLS Autofil 1807-RLS	PP	8,250 xg 13,500 xg	69 x 165
			500 mL	Autofil 1806-RLS Autofil 1808-RLS	PC	8,250 xg 13,850 xg	69 x 165
			500 mL	Nalgene 3120-9500	PPC	13,700 xg	69.5 x 170.2
			500 mL	Hanil HI_TB-500	PP		68.5 x 163

Tube Material

PPCO : Polypropylene copolymer

PP : Polypropylene

PC : Polycarbonate

4. Operation

4.1 Control Panel

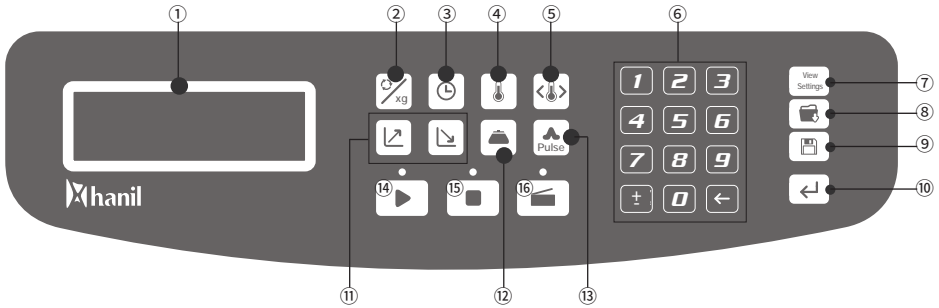

Button		Description
①	Display	- Indicate Speed/Time/Temperature/Acc.Dec.
②	Speed	- Press once : Setting the RPM / Press twice: Setting the RCF
③	Time	- Setting run time
④	Temp	- Setting temperature
⑤	Temp Limit	- Setting temperature limit range
⑥	Numeric buttons	- Enter a value using the numeric buttons
⑦	View Setting	- Verifying the setting parameters during centrifugation
⑧	Program call	- Saving a program
⑨	Program save	- Calling up a program
⑩	Enter	- Press the enter after setting the parameters
⑪	Acceleration (↗) Deceleration (↘)	- Setting acceleration step - Setting deceleration step
⑫	Rotor ID.	- When rotor id is not identified automatically, enter the rotor ID. manually
⑬	Pulse	- Short spin
⑭	Start	- Starting centrifugation
⑮	Stop	- Stopping centrifugation
⑯	Lid	- Openg the lid

4. Operation

4.2 Setting Speed

[Setting RPM]

1. Press the Speed button once.
 - ▶ RPM setting mode: RPM(rpm) display flashes.
2. Press the numeric buttons to set the desired RPM value.
3. Press the Enter button.

[Setting RCF]

1. Press the Speed button twice.
 - ▶ RCF setting mode: RCF(xg) display flashes.
2. Press the numeric buttons to set the desired RCF value.
3. Press the Enter button.

4. Operation

4.3 Setting Run Time

1. Press the Time button.
 - ▶ Time setting mode: Time 00:00:00 display flashes.
2. Press the numeric buttons to set the desired run time.
 - ▶ Up to <100hr
3. Press the Setup/Enter button.

4.4 Setting Temperature

1. Press the Temp button.
2. Press the numeric buttons to set the desired temperature.
 - ▶ -10°C ~ 40 °C
3. Press the Setup/Enter button.

4.5 Setting Temperature Limit

Temperature range that stops operation when the temperature is lower or higher than the set temperature.

1. Press the Temp limit button.
2. Press the numeric buttons to set the desired temperature limit range.
 - ▶ Default value: $\pm 30^{\circ}\text{C}$
3. Press the Setup/Enter button.

4. Operation

4.6 Setting Acceleration/Deceleration

1. Press the ACC or DEC button.
 - ▶ Acceleration setting mode: ACC (↗) display flashes.
 - ▶ Deceleration setting mode: DEC (↘) display flashes.
2. Press the numeric buttons to set the desired ACC or DEC rate.
 - ▶ ACC rate: 0~9 / DEC rate: 0~9
3. Press the Enter button.

4.7 Saving/Calling up a Program

[Saving]

1. Set the RPM(or RCF) / Run time / Accel, Decel rate / Temperature
2. Press the Program Save button.
3. Press the numeric buttons to set the desired program number.
 - ▶ Up to 0~99 :100
4. Press the Enter button.

[Calling up]

1. Press the Program Call button.
2. Press the numeric buttons to set the desired program number.
3. Press the Enter button.

4. Operation

4.8 Start/Stop/Pulse Run

[Start a run]

1. Check all parameters are correct.
2. Press the Start button.

[Stop a run]

1. Press the Stop button.

[Pulse]

It is for quick and short spin down.

After reaching the set speed, the centrifugation is decelated and stopped

1. Set the desired speed.
 - ▶ Refer to [4.2 Setting Speed]
2. Press the Pulse button.

5. Maintenance

5.1 Care Instructions

1. Regularly inspect the rotor chamber for check the motor shaft is normal.
2. Regularly check the rotor and accessories to be sure there is no damage.
3. Rotate the motor shaft with your hand to make sure it turns smoothly.
4. To prevent the rotor from sticking, lubricate the rotor drive hole which contacts motor shaft regularly.

5.2 Cleaning



- Before cleaning the centrifuge, be sure to switch off the device and disconnect the power cord.

[Outside of the device]

1. Clean the outside of device with a soft and dry cloth.
 - ▶ If the device is contaminated, use a mild cleaning fluid to clean.
2. Do not use aggressive chemicals on the device such as alcohol, benzene, acetone or phenol.
3. Make sure do not scratch the surface of device when cleaning it.
 - ▶ Do not use a metal sponge.
 - ▶ If the device is rusted, remove it with a mild detergent and wipe it with a dry cloth.

[Chamber]

1. If the rotor chamber is not dry, wipe moisture from the chamber with a dry cloth.
2. If the rotor chamber is dirty, clean it with a mild fluid to clean.

[Rotor]

1. After centrifugation, remove the rotor from the chamber and keep it upside down.
2. If any sample is spilt inside the rotor, clean it and dry well.

[Disposal]

1. In case of product is to be disposed of, the local wastes laws and regulations are to be observed.

5. Maintenance

5.3 Care Instructions for Refrigerated device

[Open the lid after centrifugation]

1. Wipe up the moisture in the chamber with a soft cloth.
2. Leave the centrifuge lid open after centrifugation.

[Remove the condensation water]

1. Remove the drain cap and empty the condensation water regularly.

[Remove dust]

1. Remove any dust from the ventilation slots regularly.

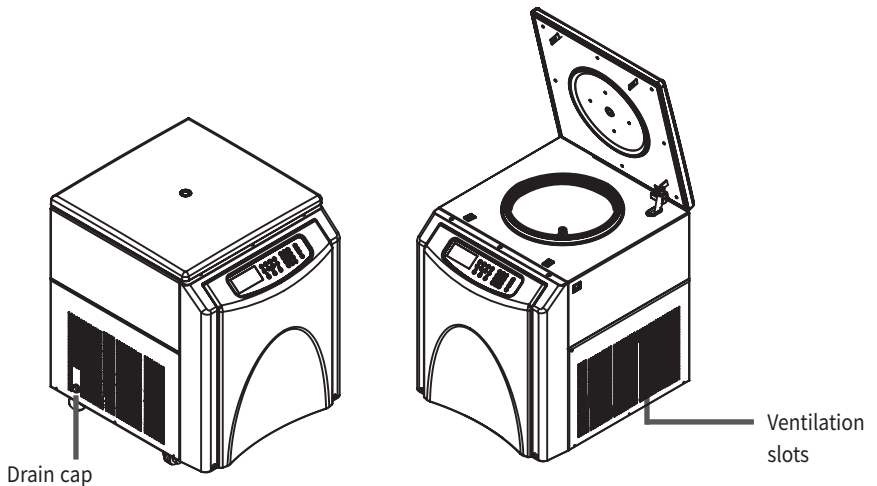

6. Troubleshooting

6.1 Possible Problems

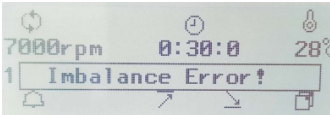
Problems	Recommended Action
Power failure	<ul style="list-style-type: none"> - Check the power cord connection. - Check the power fuse of the device.
Centrifugation cannot be started	<ul style="list-style-type: none"> - Check the lid is closed completely.
Lid cannot be opened	<ul style="list-style-type: none"> - Press the 'Lid open button'. - Check the power connection.
Lid cannot be closed	<ul style="list-style-type: none"> - Remove the dirt at the door latch and close the lid. - Check the lid latch is not damaged.
Unusual noise and vibration	<ul style="list-style-type: none"> - Check the device is installed on the hard and flat place
	<ul style="list-style-type: none"> - Reinstall the rotor symmetrically. - Reinstall the tubes symmetrically.
Imbalance error message is displayed	 <ul style="list-style-type: none"> - If there is a problem with the imbalance sensor, an imbalance error message is displayed. - In this case, pressing the start button does not work. - Contact Hanil techsupport.

6. Troubleshooting

6.2 Error Codes

Error	Message	Cause	Recommended Action
E1	Imbalance error	• Imbalance is detected.	<ul style="list-style-type: none">• Check the tightness of rotor loading.• Check the proper loading of tubes.• Check the stable ground or worktable.
E2	Over speed error	<ul style="list-style-type: none">• 10% over the set RPM.• Incorrect tuning of motor and controller.	<ul style="list-style-type: none">• Check controller and motor.• Restart the device
E3	Motor start error	• Can not reach 10 rpm within 10sec.	<ul style="list-style-type: none">• Restart the device.
E4	Door Open! Fast stop!	- When the lid is opened during operation.	<ul style="list-style-type: none">• Restart the device
E5	Low Speed error	• Can not reach 100rpm within 2sec. after start the run.	<ul style="list-style-type: none">• Restart the device
E6	System error	• Error in control system	<ul style="list-style-type: none">• Restart the device

6. Troubleshooting





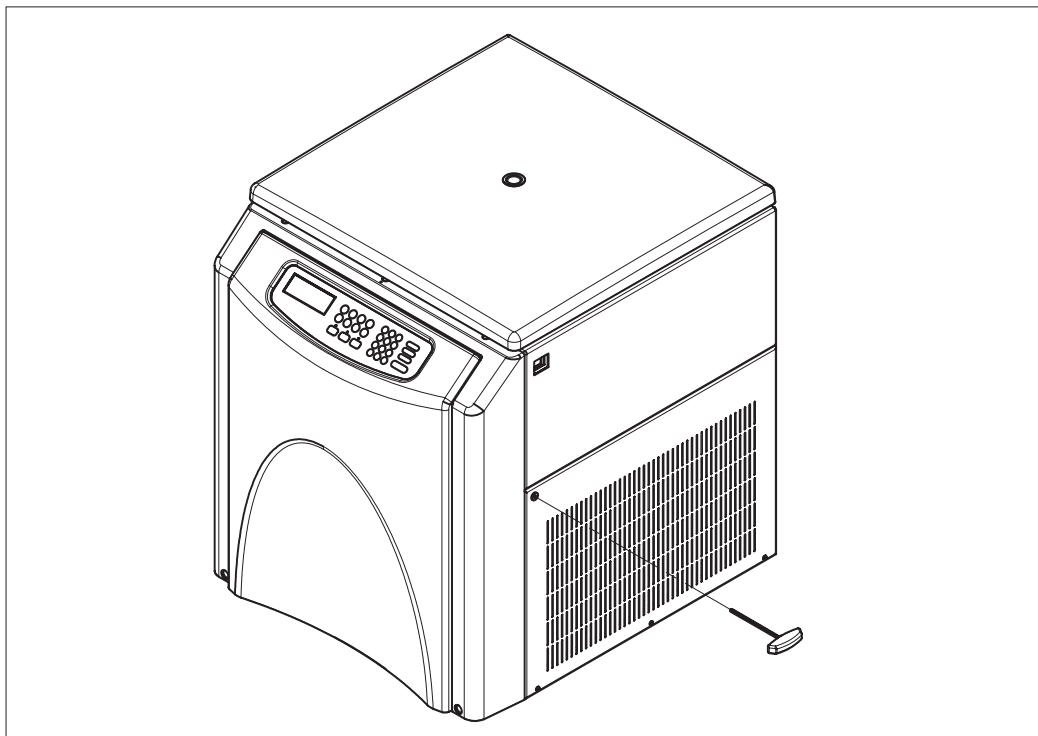

6.3 Emergency Lid Open

If the device lid cannot be opened, you can activate the emergency open manually.





1. Wait for rotor to stop before activating the emergency open.
2. Insert the T-wrench into the emergency open hole and press it until the lid is opened.



7. Rotors and Accessories

Rotor		Tube Capacity /Bottom Type	Required Adaptor	Bore Ø x L Radius (mm)	Max. RPM(rpm) Max. RCF (xg)
 A2.0-36	Hole angle : $\angle 30^\circ$ Max. Capacity : 36 x 1.5/2.0 mL Size (Ø x H) : Ø240 x 64 Max. height for tube fit : 49 mm	1.5/2.0 mL Micro-filter tube	-	11 x 37.5 115.7	18,000 41,910
		0.5 mL	TR0.5	8 x 37 111	18,000 40,208
		0.2 mL	TR0.2	6 x 21 100	18,000 36,223
 A10-12	Hole angle : $\angle 36^\circ$ Max. Capacity : 12 x 10 mL Size (Ø x H) : Ø179.9 x 82 Max. height for tube fit : 87.1 mm	10 mL Round	-	16.3 x 74.5 85.1	22,000 46,049
 A15-12	Hole angle : $\angle 30^\circ$ Max. Capacity : 12 x 15 mL Size (Ø x H) : Ø222.7 x 106 mm Max. height for tube fit : 121 mm	15 mL Round	-	17 x 96 106	22,000 57,358
 A15c-12	Hole angle : $\angle 36^\circ$ Max. Capacity : 12 x 15 mL conical Size (Ø x H) : Ø215 x 121 Max. height for tube fit : 123.2 mm	15 mL Conical	-	17 X 115 99.4	17,000 32,116
 A50-6	HHole angle : $\angle 30^\circ$ Max. Capacity : 6 x 50 mL Size (Ø x H) : Ø200 x 109 mm Max. height for tube fit : 122.7 mm	50 mL Round	-	29 x 100 96.1	22,000 52,001
		15 mL Round	TR15(50)	17 x 94 89.9	22,000 48,646
		15 mL Conical	TR15c(50)	17 x 105 91	22,000 49,241
 A50c-6	Hole angle : $\angle 23^\circ$ Max. Capacity : 6 x 50 mL conical Size (Ø x H) : Ø205.7 x 119 mm Max. height for tube fit : 118.1 mm	50 mL Conical	-	30 x 108.6 91	17,000 29,402

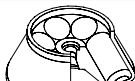
7. Rotors and Accessories

Rotor		Tube Capacity /Bottom Type	Required Adaptor	Bore Ø x L Radius (mm)	Max. RPM(rpm) Max. RCF (xg)
 <p>A50-8</p>	<p>Hole angle : $\angle 30^\circ$ Max. Capacity : 8 x 50 mL Size (ø x H) : ø213 x 110.7 mm Max. height for tube fit : 110.7 mm</p>	50 mL Round	-	29 x 100 98.9	20,000 44,228
		15 mL Round	TR15(50)	17 x 94 92.8	20,000 41,500
		15 mL Conical	TR15c(50)	17 x 105 93.9	20,000 41,992
 <p>A85-6</p>	<p>Hole angle : $\angle 25^\circ$ Max. Capacity : 6 x 85 mL Size (ø x H) : ø209.1 x 112 mm Max. height for tube fit : 115.4 mm</p>	85 mL Round	-	38.3 x 95 97.6	20,000 43,647
		50 mL Round	TR50(85)	29 x 95 92.9	20,000 41,545
		50 mL Conical	TR50c(85)	29.5 x 100 93	20,000 41,590
		15 mL Round	TR15(85)	17 x 94 89	20,000 39,800
		15 mL Conical	TR15c(85)	17 x 100 89.2	20,000 39,890
 <p>A250-6</p>	<p>Hole angle : $\angle 25^\circ$ Max. Capacity : 6 x 250 mL Size (ø x H) : ø295.6 x 147.8 mm Max. height for tube fit : 132 mm</p>	250 mL Flat	-	62 x 103 138.3	12,000 22,265
 <p>A500-6</p>	<p>Hole angle : $\angle 25^\circ$ Max. Capacity : 6 x 500 mL Size (ø x H) : ø336 x 179 mm Max. height for tube fit : 168.5 mm</p>	500 mL Flat	-	70 x 141 158.7	9,000 14,372
 <p>A1000-4</p>	<p>Hole angle : $\angle 25^\circ$ Max. Capacity : 4 x 1,000 mL Size (ø x H) : ø350 x 196 mm Max. height for tube fit : 184.8 mm</p>	1,000 mL Flat	-	98 x 144 169.9	8,000 12,157



RECYCLABLE



16, Arayuk-ro, Gimpo, REP of Korea
+82-2-3452-8966
technicalsupport@ihantil.com
www.ihantil.com

Doc. No. : OMS1PDEN2001